

Bend 15°

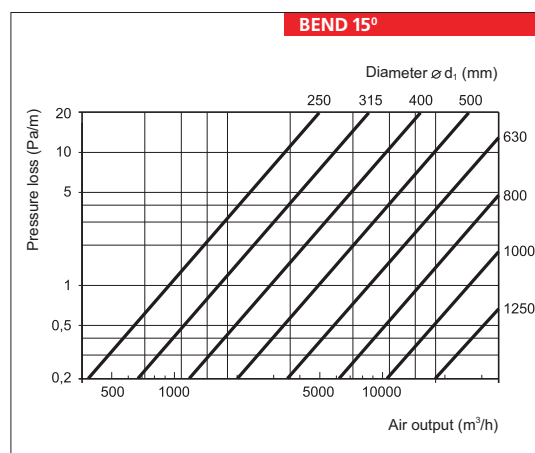
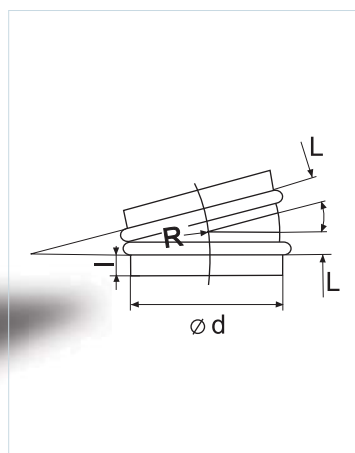

Type	Diameter (d), mm	Steel thickness (p), mm	Length (L), mm	l, mm	R, mm
Bend 15-125	125	0.50	16	50	125
Bend 15-140	140	0.50	18	50	140
Bend 15-150	150	0.50	20	50	150
Bend 15-160	160	0.50	21	50	160
Bend 15-180	180	0.50	24	50	180
Bend 15-200	200	0.50	26	50	200
Bend 15-224	224	0.50	30	50	224
Bend 15-250	250	0.50	33	50	250
Bend 15-280	280	0.50	37	50	280
Bend 15-315	315	0.50	42	50	315
Bend 15-355	355	0.50	47	60	355
Bend 15-400	400	0.70	53	60	400
Bend 15-450	450	0.70	59	60	450
Bend 15-500	500	0.70	68	80	500
Bend 15-560	560	0.70	73	80	560
Bend 15-600	600	0.70	79	80	600
Bend 15-630	630	0.70	83	80	630
Bend 15-710	710	0.70	93	80	710
Bend 15-800	800	0.70	105	80	800
Bend 15-900	900	1.00	118	100	900
Bend 15-1000	1000	1.00	132	100	1000
Bend 15-1120	1120	1.00	147	100	1120
Bend 15-1250	1250	1.00	165	100	1250